

CUSTOMER:		
JOB:	MOLD: SIGN-330	
BAY# 125	STONE COLOR:	
DATE:	SCALE: $\frac{3}{4}'' = 12''$	NEED:

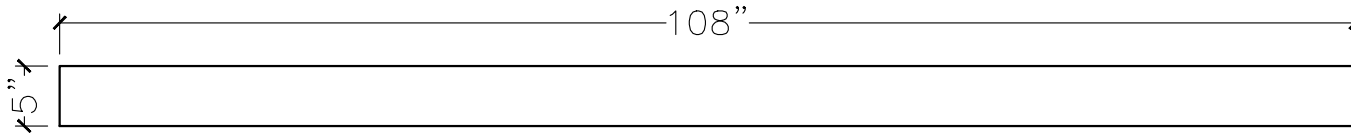

TOP VIEW

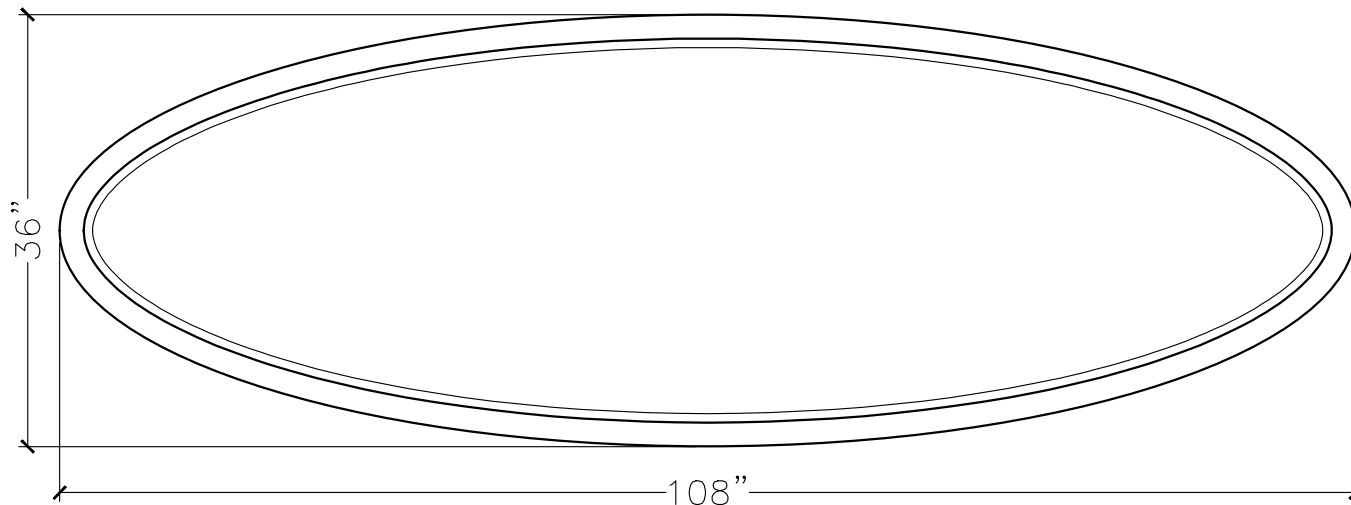

FRONT VIEW



SECTION VIEW