

JOB:	MOLD: RB-62	
BAY#: 91	STONE COLOR:	
DATE:	SCALE: 3"=12"	NEED:

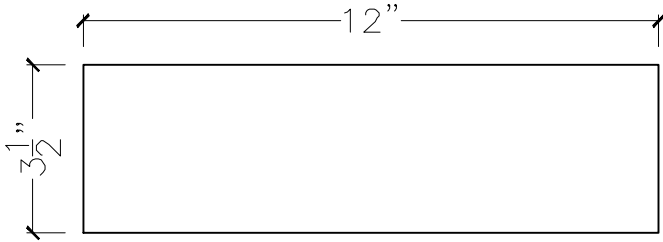

TOP VIEW

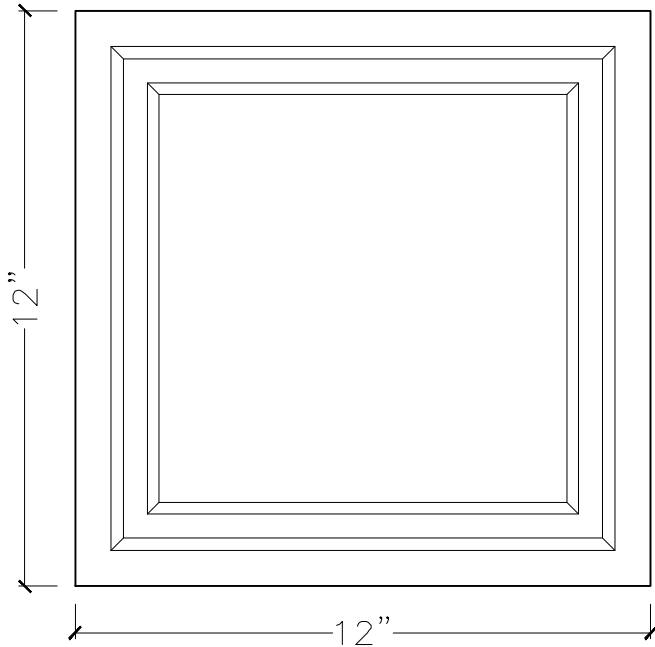

FRONT VIEW

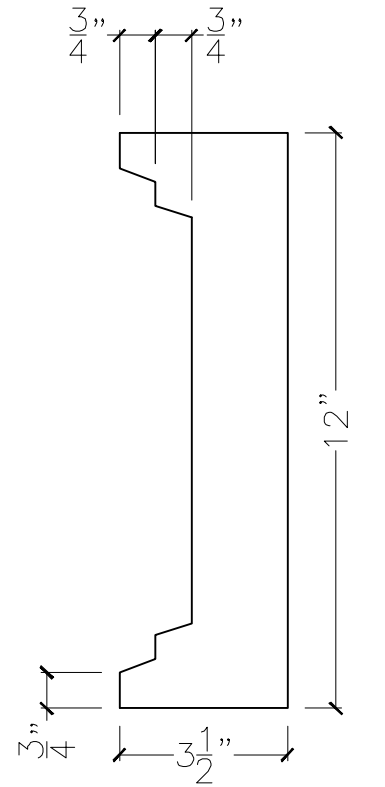

SECTION VIEW