

JOB:	MOLD: RB-29
BAY# 60	STONE COLOR:
DATE:	SCALE: $1\frac{1}{2}''=12''$ NEED:

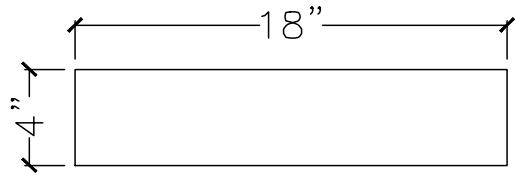

TOP VIEW

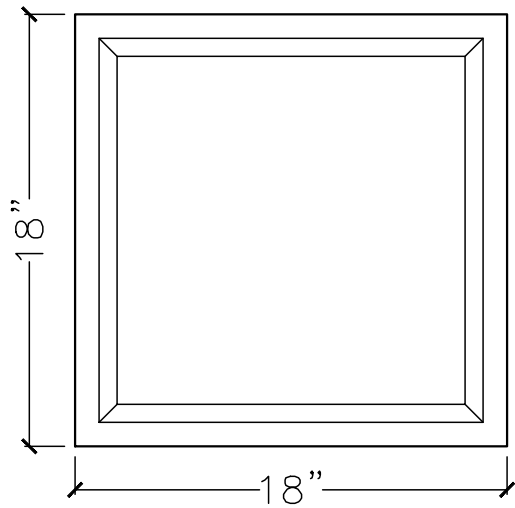

FRONT VIEW

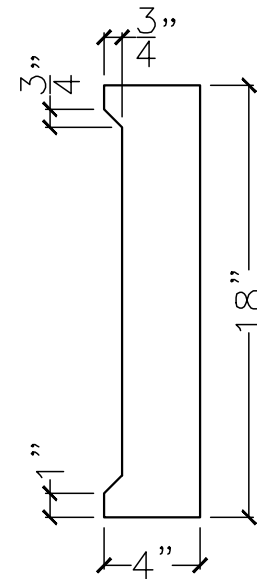

SECTION VIEW