

JOB:	MOLD: RB-92
BAY#: 91	STONE COLOR:
DATE:	SCALE: 1"=12" NEED:

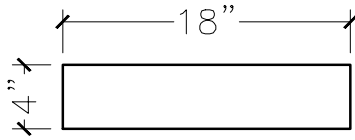

TOP VIEW

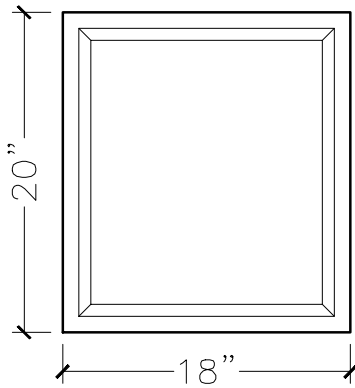

FRONT VIEW

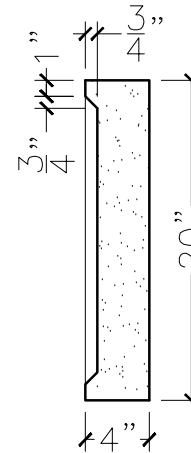

SECTION VIEW