

CUSTOMER:	
JOB:	MOLD: CC-39
BAY#: 111	STONE COLOR:
DATE:	SCALE: $\frac{3}{4}'' = 12''$ NEED:

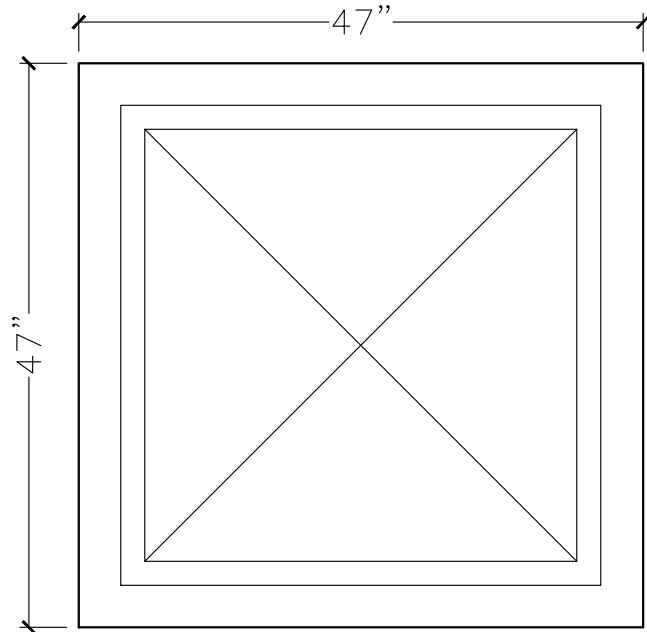

TOP VIEW

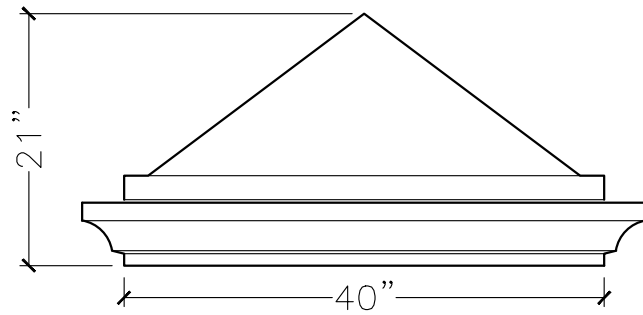

FRONT VIEW

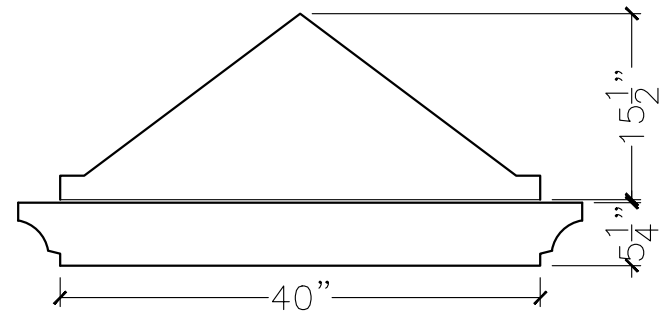

SECTION VIEW