

CUSTOMER:		
JOB:	MOLD: CC-27	
BAY#: 100-A	STONE COLOR:	
DATE:	SCALE: 1"=12"	NEED:

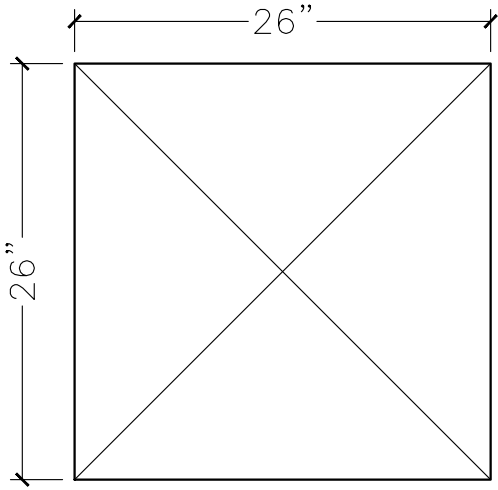

TOP VIEW

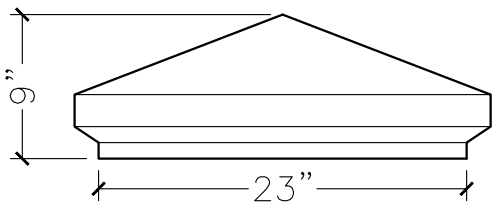

FRONT VIEW

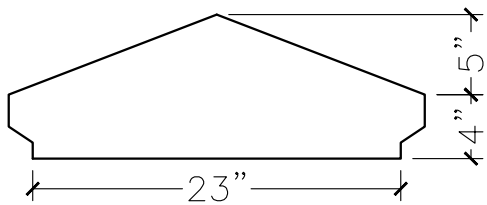

SECTION VIEW