

CUSTOMER:	
JOB:	MOLD: CC-170
BAY#: 303-B	STONE COLOR:
DATE:	SCALE: $\frac{1}{2}'' = 12''$ NEED:

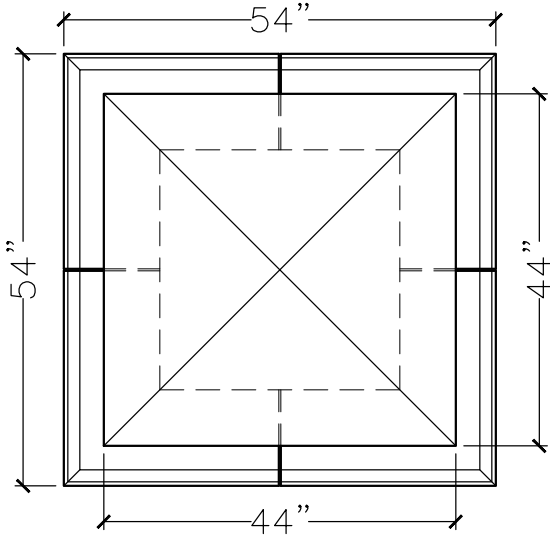

TOP VIEW

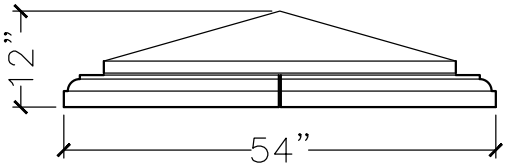

FRONT VIEW

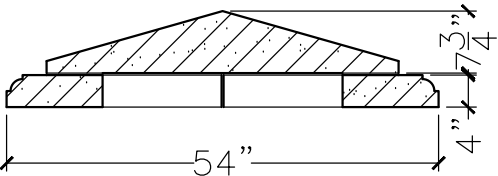

SECTION VIEW