

CUSTOMER:	
JOB:	MOLD: CC-486
BAY#: 343-B	STONE COLOR:
DATE:	SCALE: $1\frac{1}{2}'' = 12''$ NEED:

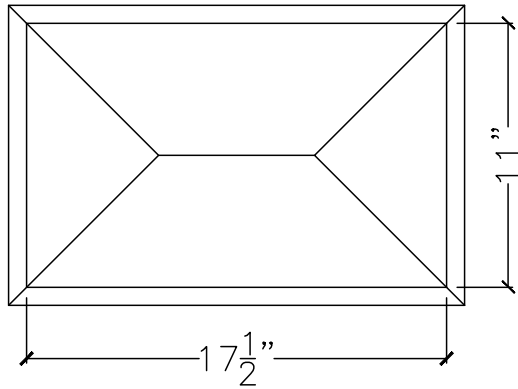

TOP VIEW

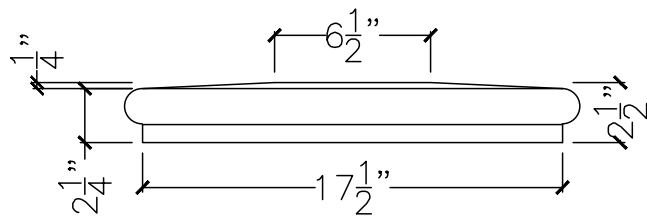

FRONT VIEW

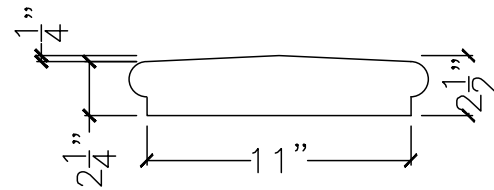

SECTION VIEW