

CUSTOMER:		
JOB:	MOLD: CC-395	
BAY#	STORAGE BUILDING	STONE COLOR:
DATE:	SCALE: $\frac{3}{4}'' = 12''$	NEED:

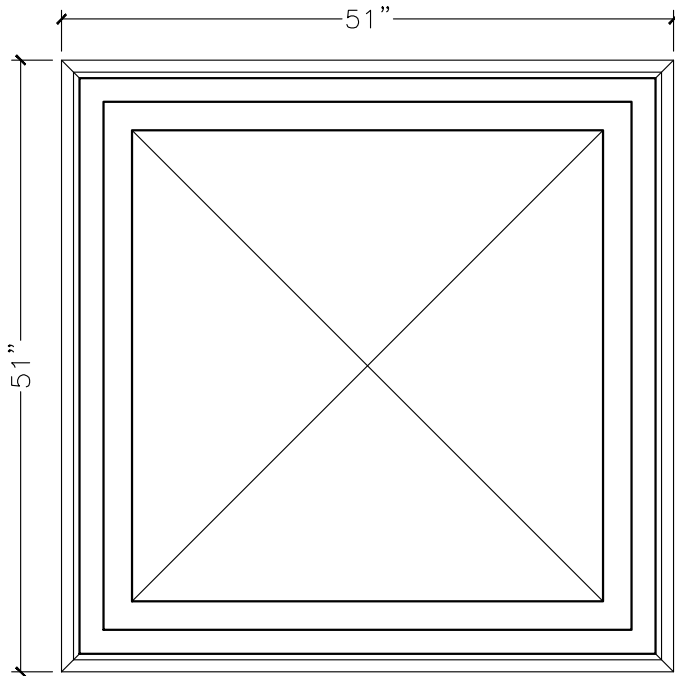

TOP VIEW

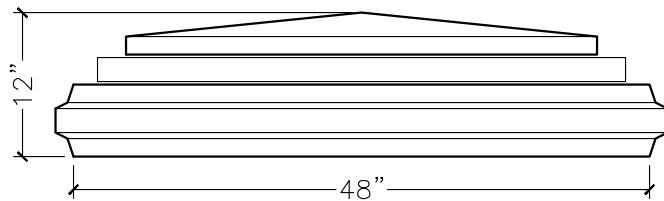

FRONT VIEW

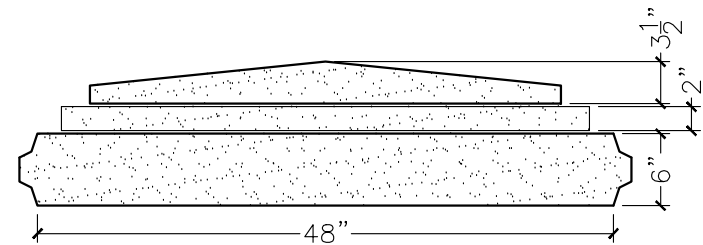

SECTION VIEW