

CUSTOMER:		
JOB:	MOLD: CC-365	
BAY#: 82-B	STONE COLOR:	
DATE:	SCALE: $\frac{1}{2}'' = 12''$	NEED:

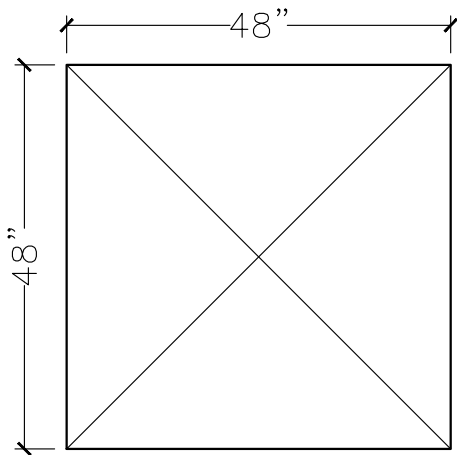

TOP VIEW

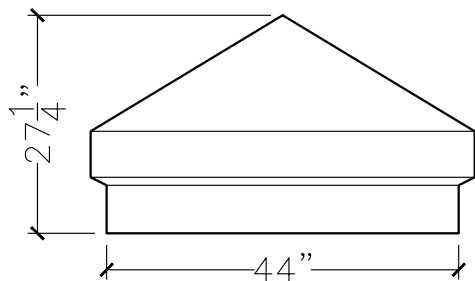

FRONT VIEW

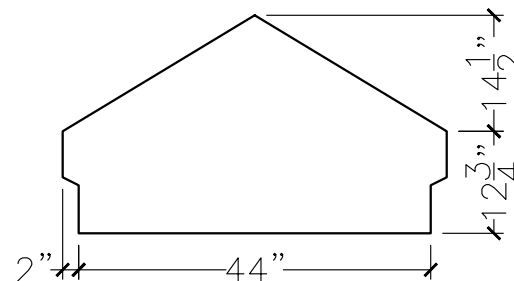

SECTION VIEW