

JOB:	MOLD: CC-208
BAY# 95-B	STONE COLOR:
DATE:	SCALE: $1\frac{1}{2}''=12''$ NEED:

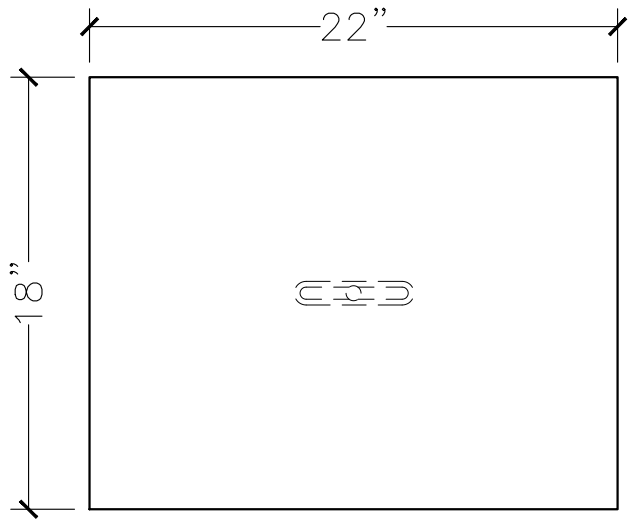

TOP VIEW

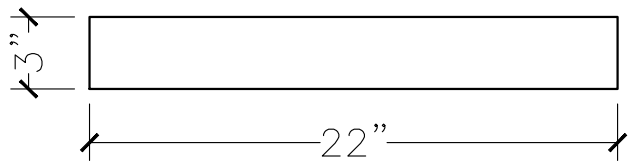

FRONT VIEW

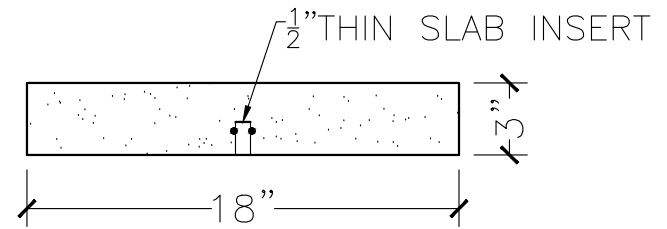

SECTION VIEW