

CUSTOMER:	
JOB:	MOLD: CC-204
BAY#: 114	STONE COLOR:
DATE:	SCALE: $\frac{1}{2}'' = 12''$ NEED:

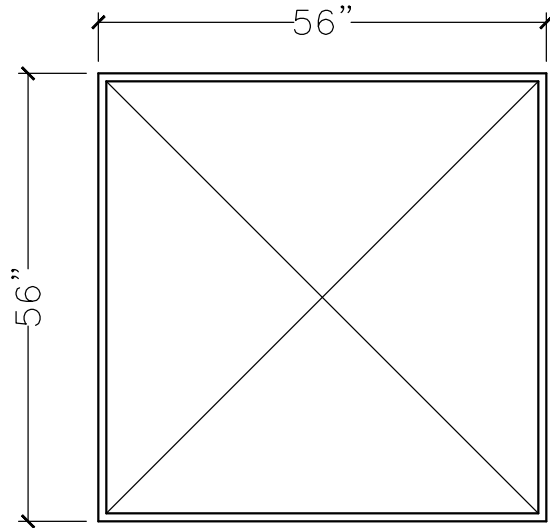

TOP VIEW

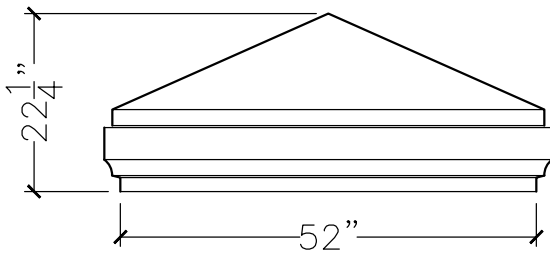

FRONT VIEW

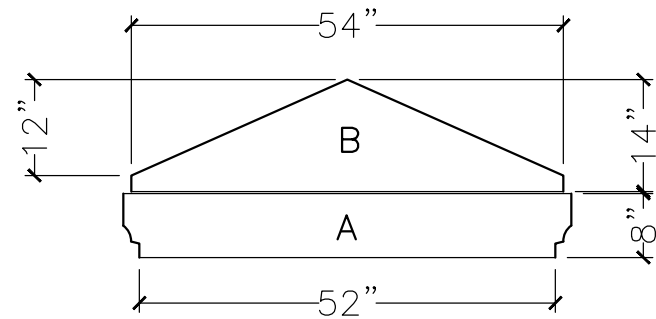

SECTION VIEW