

JOB:	MOLD: CB-38
BAY# 12-B	STONE COLOR:
DATE:	SCALE: $\frac{3}{4}'' = 12''$ NEED:

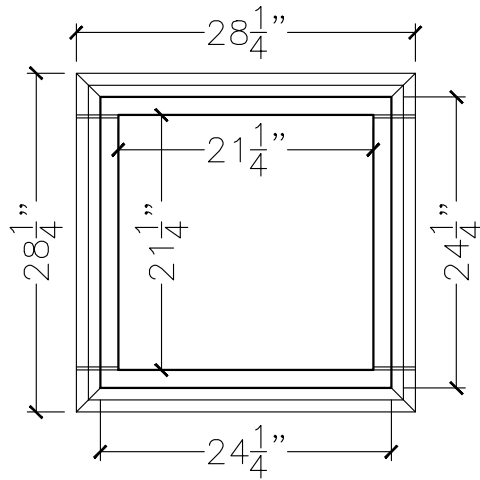

TOP VIEW

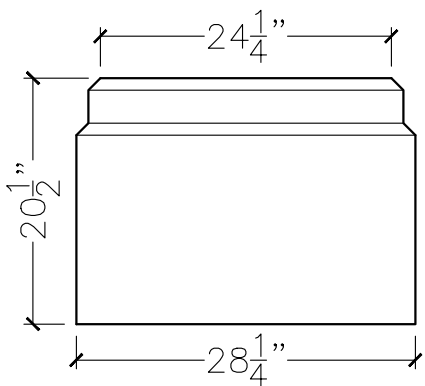

FRONT VIEW

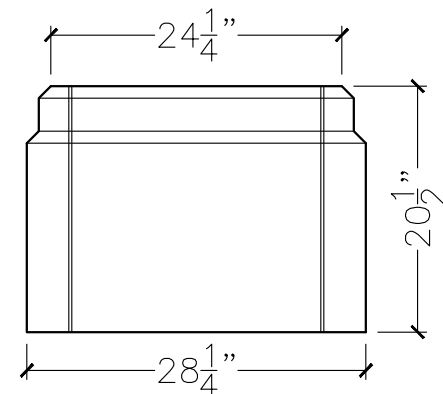

SIDE VIEW