

CUSTOMER:	
JOB:	MOLD: CB-29
BAY#: 327-A	STONE COLOR:
DATE:	SCALE: $\frac{1}{2}'' = 12''$ NEED:

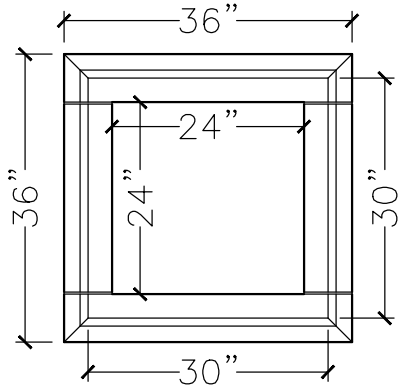

TOP VIEW

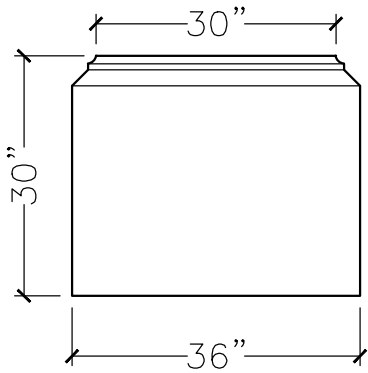

FRONT VIEW

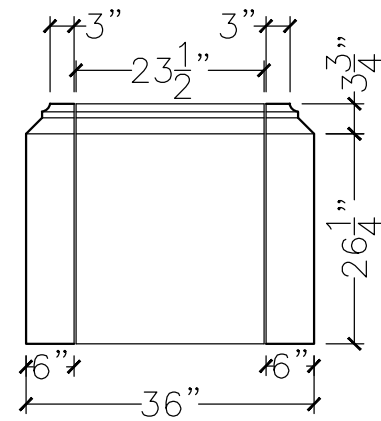

SIDE VIEW