

CUSTOMER:	
JOB:	MOLD: AB-31
BAY#: 176	STONE COLOR:
DATE:	SCALE: 3"=12" NEED:

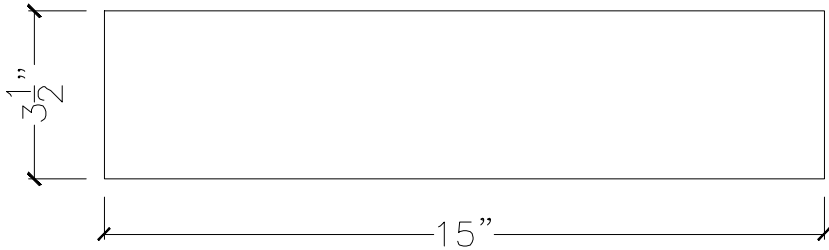

TOP VIEW

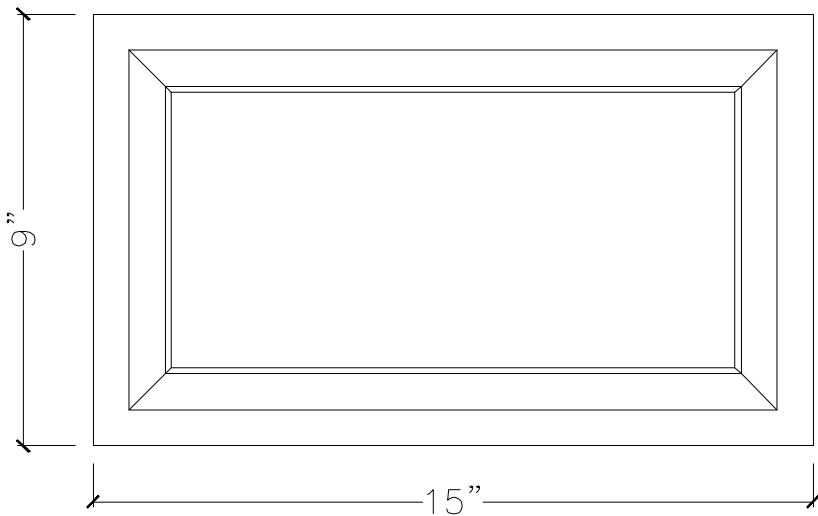

FRONT VIEW

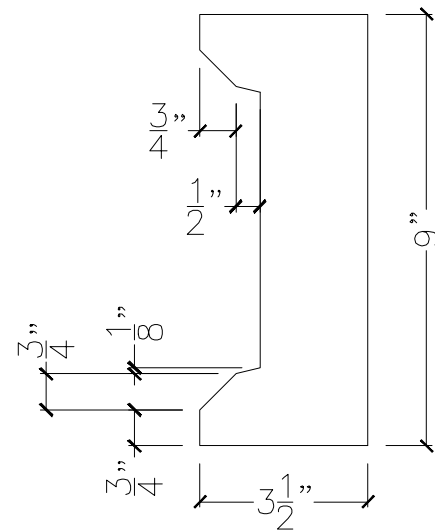

SECTION VIEW