

CUSTOMER:		
JOB:	MOLD: AB-30	
BAY#: 176	STONE COLOR:	
DATE:	SCALE: 3"=12"	NEED:

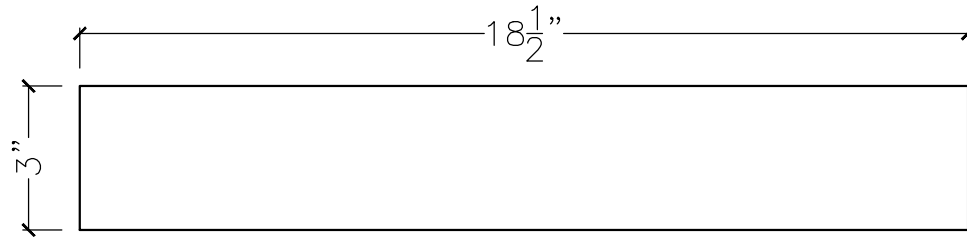

TOP VIEW

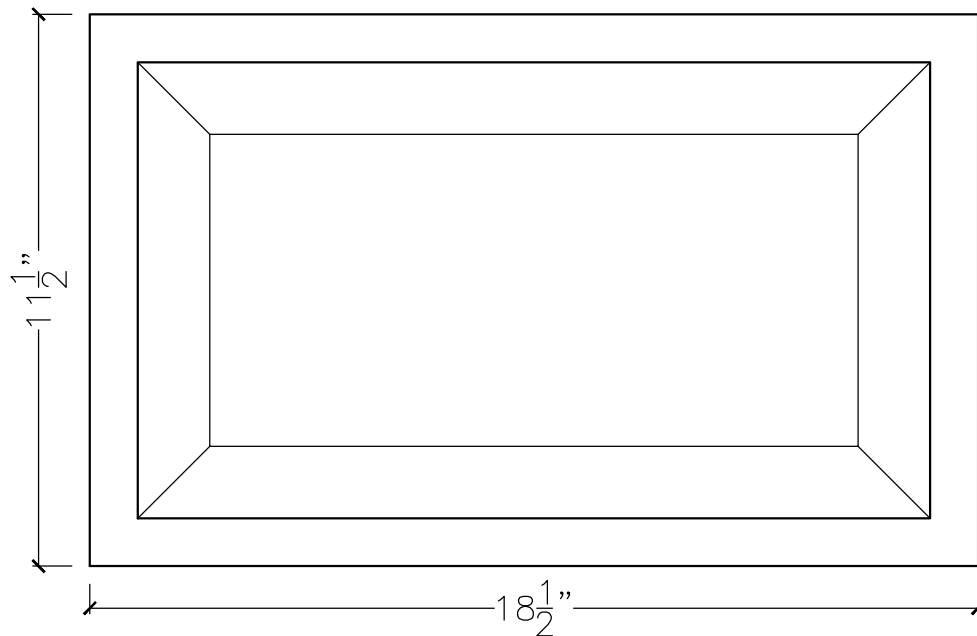

FRONT VIEW

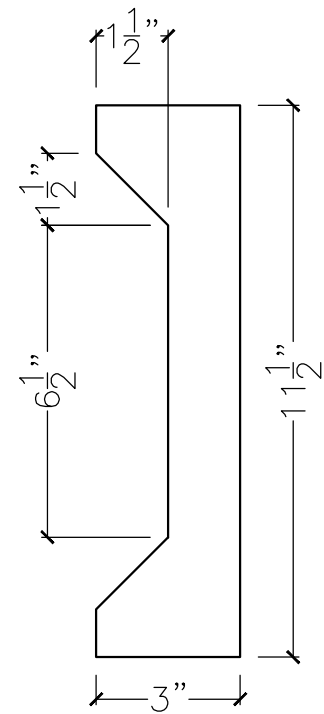

SECTION VIEW