

CUSTOMER:	
JOB:	MOLD: 38"x38"CC-9
BAY# 70-B	STONE COLOR:
DATE:	SCALE: $\frac{3}{4}" = 12"$ NEED:

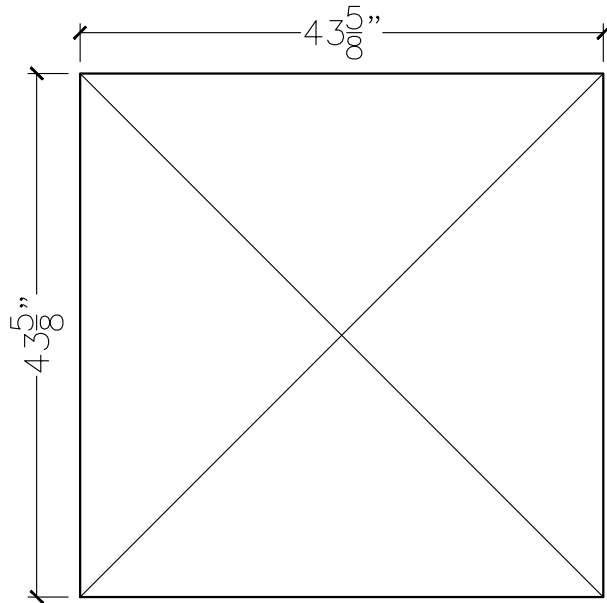

TOP VIEW

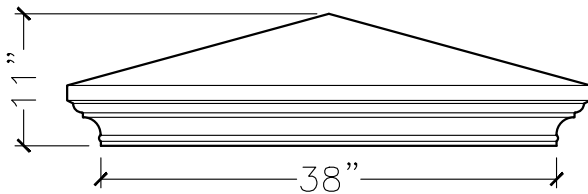

FRONT VIEW

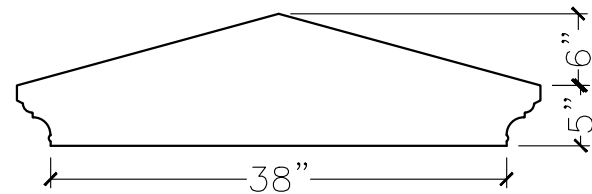

SECTION VIEW